



Rodless Pneumatic Cylinders Magnetically Coupled

P1Z Series

aerospace
climate control
electromechanical
filtration
fluid & gas handling
hydraulics
pneumatics
process control
sealing & shielding



ENGINEERING YOUR SUCCESS.

Contents

Rodless Pneumatic Cylinder Magnetically Coupled

Rodless Pneumatic Cylinder
Magnetically Coupled

P1Z Series
Ø 16 - 40 mm











	Page
Basic Version	5
Features	5
Description	5
Technical data	6
Loads, forces and moments	7
Cushioning diagram	8
Installation tips for use with external guide	8
Dimensions	9
Order instructions	11
Guided Version	13
Features	13
Description	13
Overview	14
Technical Data	15
Loads, forces and moments	16
Dimensions	18
Magnetic Switches	21
Order instructions	23
Spare parts	24

Rodless Pneumatic Cylinder
Magnetically Coupled

P1Z Series

Ø 16 - 40 mm

Overview P1Z

<p>Basic Version</p>		<p>Guided Version</p>	
<p>Hexagonal nuts (included in scope of delivery)</p>		<p>Air connection on both sides Standard</p>	
<p>Flange mounting Option</p>		<p>Air connection at one end Option</p>	
<p>Foot mounting Option</p>		<p>With elastomeric bumpers Standard</p>	
		<p>With hydraulic shock absorbers Option</p>	
		<p>Profile rail for magnetic switches Option</p>	
		<p>Profile rail with magnetic switches Option</p>	

Basic Version

Rodless Pneumatic Cylinder
Magnetically Coupled

P1Z Series

Basic Version

Ø 16 - 40 mm

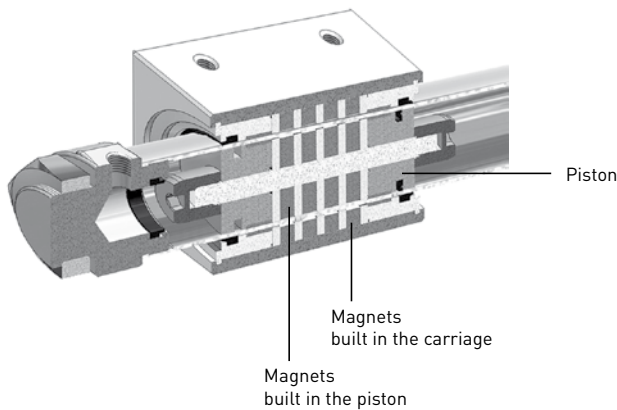
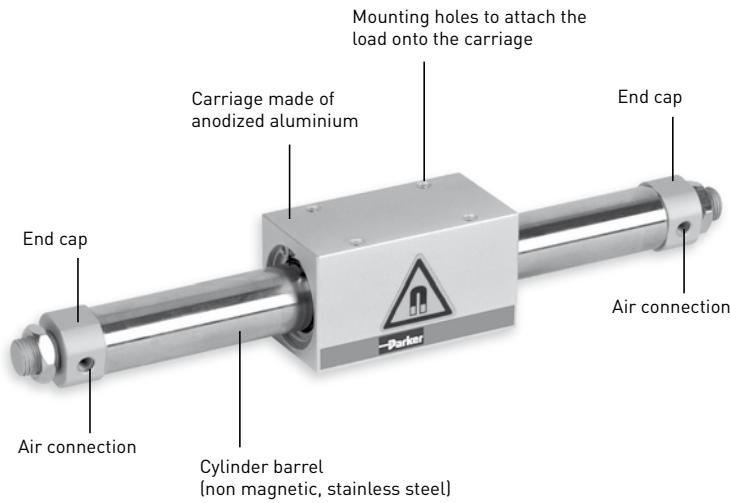

Features

P1Z Basic Version

- Double acting
- Magnetically coupled without mechanical connection
- Mechanical protection in case of occasional overload due to magnetic uncoupling
- Piston chamber and carriage are pressure tight
- Pressure tight and leak free system
- Dirt and dust cannot enter
- With adjustable pneumatic end cushioning on both sides
- Carriage is free to rotate 360° around the cylinder axis
- Various mounting arrangements

Description

The P1Z is a rodless pneumatic cylinder. The piston and the carriage are equipped with ring magnets. The motion is transmitted via the magnetic force locking between the piston and the carriage.

P1Z Series

Basic Version

Ø 16 - 40 mm

Mounting and technical data

- The loads can be fitted onto the carriage by 4 tapped holes.
- The cylinder is mounted at the end caps with hexagonal nuts, flange or foot mountings.

Mounting



With 2 hexagonal nuts to fix the cylinder
(included in scope of delivery)



Flange mounting (pair)
option



Foot mounting (pair)
option

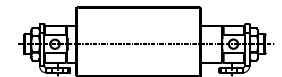
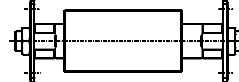

Technical data

Piston diameter Ø [mm]	16	20	25	32	40
Max. stroke length [mm]	1000	1500	2000	2000	2000
Stroke tolerance [mm] up to 1000 mm	0/+1.5				
Stroke tolerance [mm] > 1000 mm	0/+2				
Temperature range [°C]	0 to 60				
Operating medium	Filtered compressed air, dry, lubricated or unlubricated * (other media on request)				
Air supply port size	M5	G1/8	G1/8	G1/8	G1/4
Max. magnetic coupling force [N]	157	236	383	703	942
Velocity range [m/s]	0.1 to 1.3				
Min. operating pressure [bar]	1.8				
Max. operating pressure [bar]	6.5	7			
Cushion length [mm]	9	15	15	12	19
Weight [kg]					
at 0 mm stroke	0.28	0.46	0.83	1.35	2.01
per 100 mm stroke	0.043	0.082	0.088	0.14	0.16

* if external lubrication is added, this must always be continued.

Materials

Cylinder barrel	Stainless steel
Carriage	Al, anodized
End cap	Al, anodized
Seals	NBR



Loads, forces and moments

Forces [N]

Piston Ø [mm]	16	20	25	32	40
Theoretical force at 6 bar [N]	120	188	295	483	754
Max. magnetic coupling force [N]	157	236	383	703	942

Permissible lateral force, depending on the stroke length

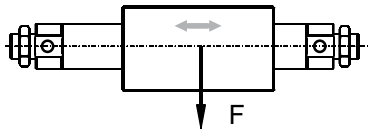

Ø [mm]	Permissible lateral force F [N]
16	30.0
20	50.0
25	70.0
32	100.0
40	165.0

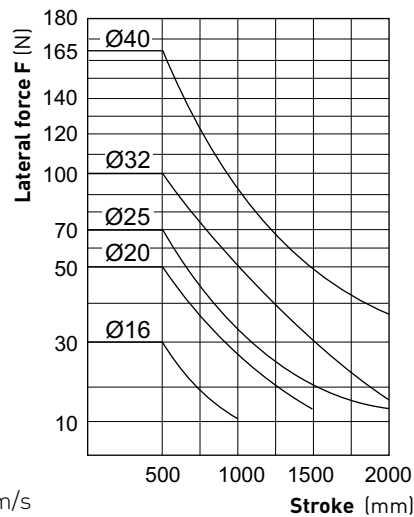

The values are based on velocities $v \leq 0.4 \text{ m/s}$

Permissible axial load, horizontal mounting

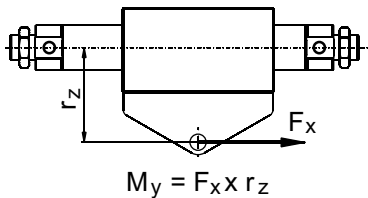

Ø [mm]	Max. Moment My [Nm]
16	1.2
20	2.5
25	3.8
32	8.5
40	13.0

Permissible axial load, vertical mounting

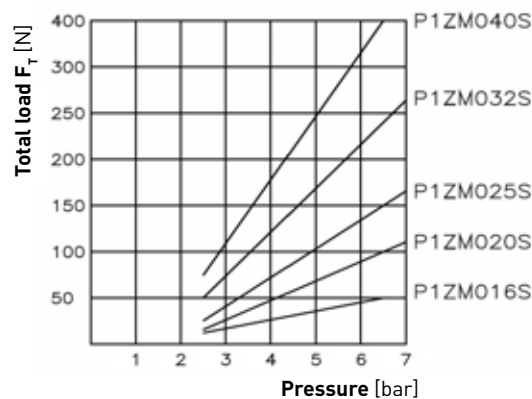
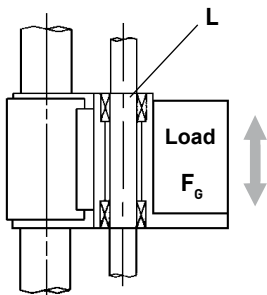

L = Weight of the external carriage

F_g = Load

F_T = Total load = Load F_g + Weight of the external carriage L + Force due to friction

Rodless Pneumatic Cylinder
Magnetically Coupled

P1Z Series

Basic Version

Ø 16 - 40 mm

Loads, forces and moments

If the operating conditions are outside of the permissible values, either the P1Z guided version or the P1Z in combination with an external guide should be used!
Please note page 8.



Dynamic forces must not exceed the maximum magnetic coupling force!

Rodless Pneumatic Cylinder
Magnetically Coupled

P1Z Series

Basic Version

Ø 16 - 40 mm

If the permitted limit values are exceeded, additional shock absorbers should be fitted in the area of the centre of gravity.

Cushioning diagram

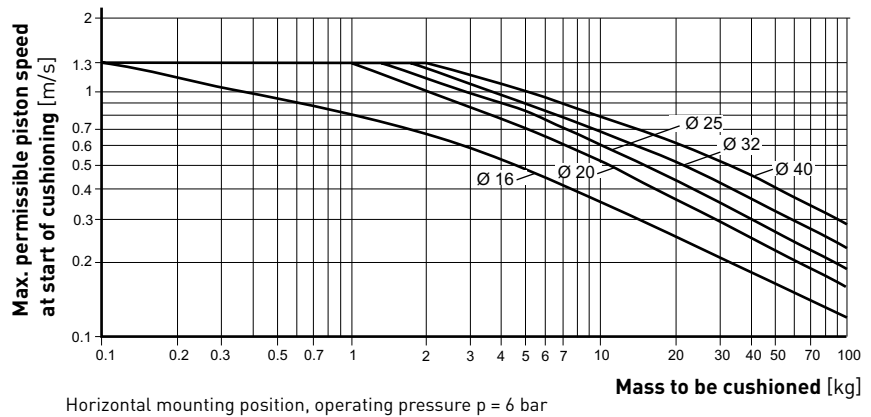

Installation tips for use with external guide

When stopping a load having a large inertia force at the stroke end, tilting of the carriage and damage to the bearings and cylinder barrel may occur (fig. left).

To prevent this, the force transmission should be realized at the middle axis of the cylinder.

The combination of the shock absorber with an end stop, can help to prevent the tilting of the carriage (fig. right).

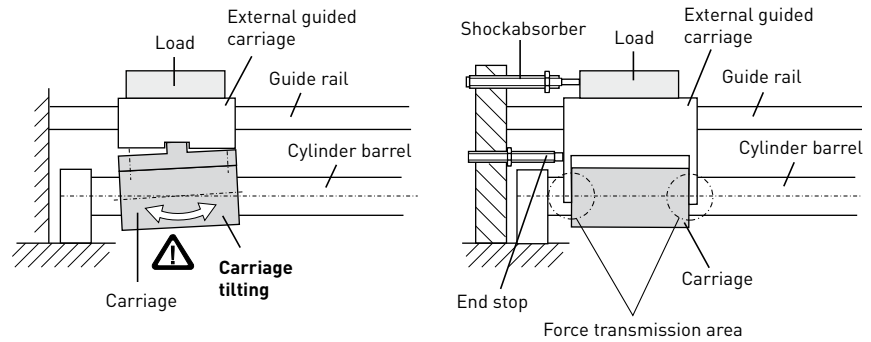

Dimensions

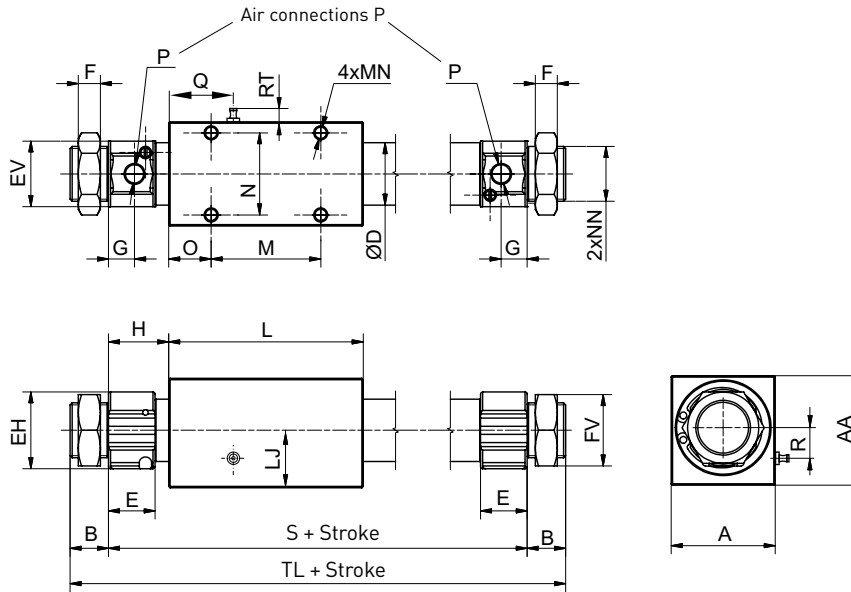

Rodless Pneumatic Cylinder
Magnetically Coupled

P1Z Series

Basic Version

Ø 16 - 40 mm

Dimensions

Ø [mm]	A	AA	B	ØD	E	EH	EV	F	FV	G	H	L	LJ
16	32	34	10	18	14	18	18	4	14	5.5	18.5	61	16
20	38	40	14	22.8	17	28	24	8	26	9.5	22	71	19
25	48	48	16	27.8	17	34	30	8	32	9.5	22	76	24
32	60	60	16	35	17	40	36	8	32	9.5	23	87	30
40	70	70	16	43.0	21	48	45	10	41	11	29	92	35

Ø [mm]	M	MN	N	NN	O	P	Q	R	RT	S	TL
16	34	M4 x 0.7 x 6	25	M10 x 1	13.5	M5 x 0.8	-	-	-	98	118
20	40	M5 x 0.8 x 8	30	M20 x 1.5	15.5	G 1/8	-	-	-	115	143
25	50	M5 x 0.8 x 8	30	M26 x 1.5	13	G 1/8	21	16	9	120	152
32	50	M6 x 1 x 10	40	M26 x 1.5	18.5	G 1/8	-	-	-	133	165
40	60	M6 x 1 x 10	40	M32 x 1.5	16	G 1/4	24	21	9	150	182





Flange mountings									
Ø [mm]	F	Ø FD	FW	FX	FY	FZ	T	LS	Order no.
16	5.2	-	42	33	-	20	2.3	92	PDC15-FH*
20	-	6	52	40	20	32	3	115	PK1A20-FH*
25	-	7	80	64	28	44	5	120	PK1A25-FH*
32	-	7	80	64	28	44	5	133	PK1A25-FH*
40	-	7	80	64	28	44	5	150	PK1A40-FH*

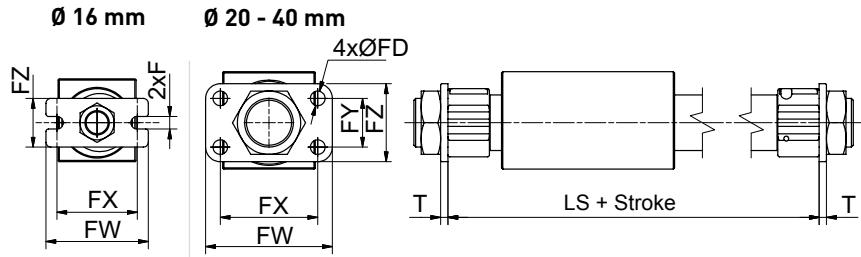
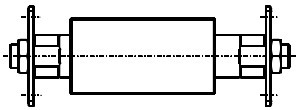

Material: galvanised steel
 * The mountings are supplied in pairs.

Foot mountings

Ø [mm]	t	L	LC	ØLD	LE	LF	LH	LJ	LK	LX	LY	LS	LT	XL	XM	Order no.
16	2.3	14.8	8.8	-	5.2	6	14	16	-2	33	42	109.6	79	121.6	96.6	PDC15-LB*
20	3	28	18	6.2	-	10	23	19	4	30	43	151	85	171	121	PK1A20-LB*
25	3	35	23	7	-	12	30	24	6	46	62	166	**	222	**	PK1A25-LB*
32	3	35	23	7	-	12	30	30	0	46	62	179	**	203	**	PK1A25-LB*
40	3	36	24	7	-	12	30	35	5	46	62	198	**	254	**	PK1A40-LB*

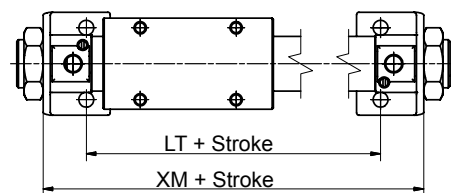
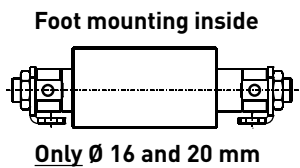
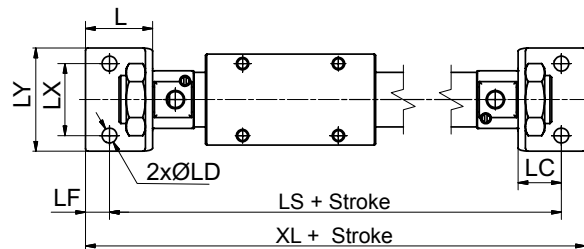
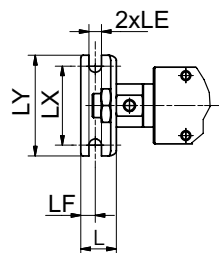
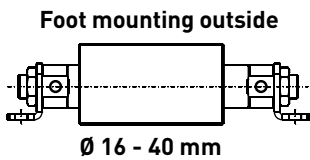
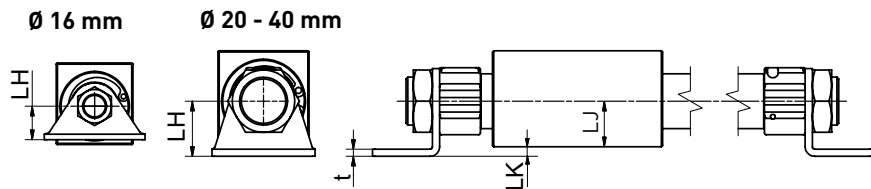

Material: galvanised steel
 * The mountings are supplied in pairs.

** Inside foot mounting is not possible.

Order instructions – Basic Cylinder – Series P1Z

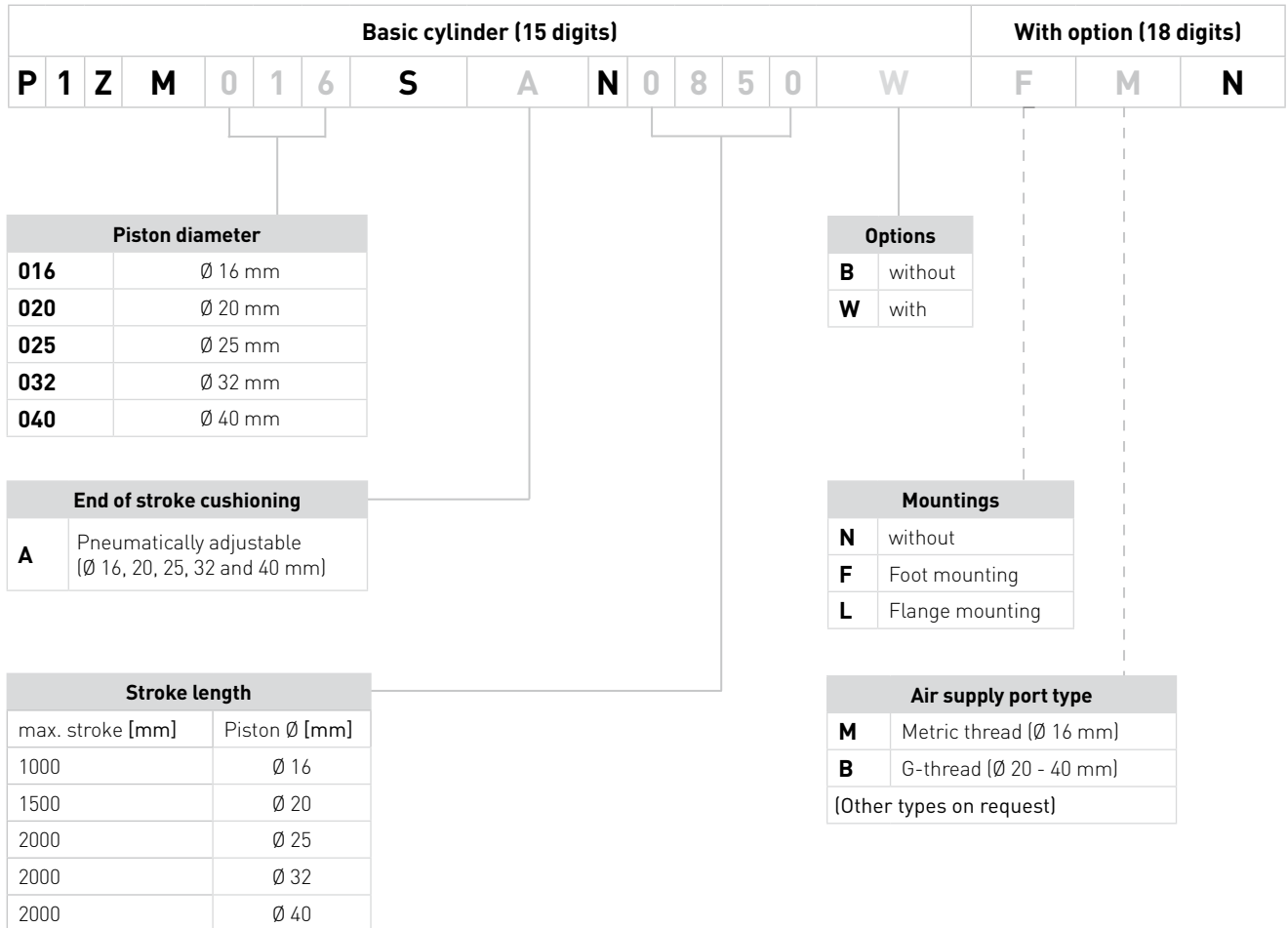

Order code examples:

- **P1ZM016SAN0100B** ∅ 16 mm, stroke 100 mm, supplied with hexagonal nuts on each end cap.
- **P1ZM020SAN1000WFBN** ∅ 20 mm, stroke 1000 mm, with foot mounting at both end caps.

Guided Version

Rodless Pneumatic Cylinder
Magnetically Coupled

P1Z Series Guided Version

Ø 16 - 40 mm

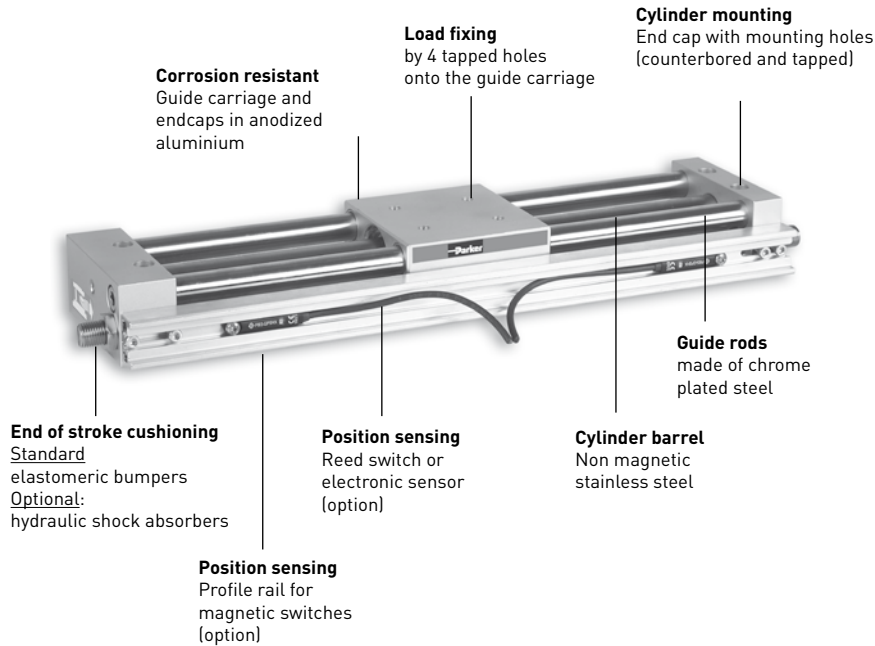

Features

Guided Version P1Z

- Double acting with guide
- Magnetically coupled without mechanical connection
- Mechanical protection in case of occasional overload due to magnetic uncoupling
- Piston chamber and Slide are pressure tight
- Pressure tight and leak free system
- Air connection at one end (option)
- End of stroke cushioning: with elastomeric bumpers (standard), with hydraulic shock absorbers (option)
- Position sensing: Al-profile rail for magnetic switches (option). Magnetic switches available as reed switches or as electronic sensors (option).

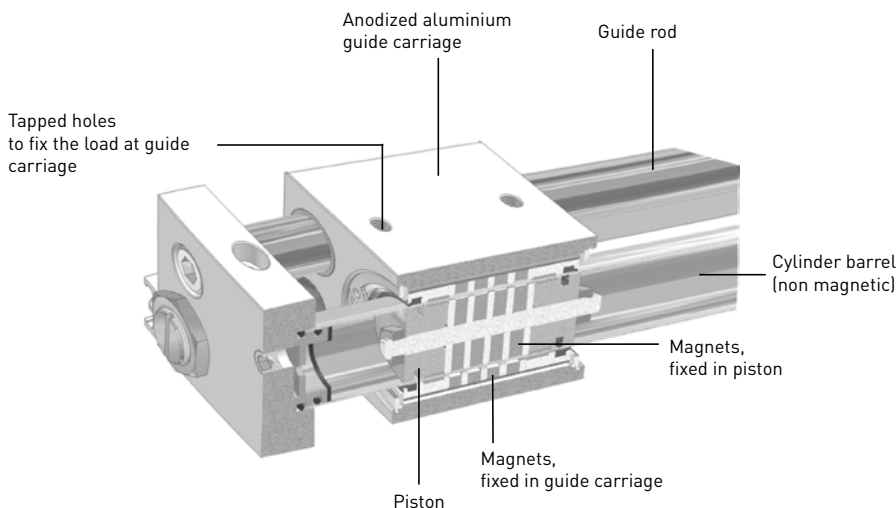

Description

The P1Z is a rodless pneumatic cylinder with guide. The piston and the guide carriage are equipped with ring magnets.

The motion is transmitted via the magnetic force between the piston and the guide carriage.

The guided version consists of a carriage fitted with 4 plain bearings, guided on 2 guide rods. The design provides high rigidity, accurate guidance and a non rotating movement.

Rodless Pneumatic Cylinder
Magnetically Coupled

P1Z Series Guided Version

Ø 16 - 40 mm

Overview

The end of stroke cushioning for light loads is provided by elastomeric bumpers (standard).

For medium and heavy loads hydraulic shock absorbers should be used (option).

The guide carriage is fitted with a magnet for position sensing (standard)

An Al-profile rail for magnetic switches is available as an option. The rail is located on the same side as the elastomeric bumpers or the shock absorbers.

Reed switches or electronic sensors in several versions can be moved in the profile rail along the entire stroke length. (Versions of magnetic switches refer to page 21.)

Air connection



Guided version P1Z and air connection on both sides (standard)



Guided version P1Z and air connection at one end (option)

End of stroke cushioning



Guided version P1Z and elastomeric bumpers (standard)



Guided version P1Z and hydraulic shock absorbers (option)

Position sensing



Guided version P1Z with magnet in the guide carriage for position sensing (standard).



Guided version P1Z and Al-profile rail for magnetic switches (option).



Guided version P1Z and Al-profile rail with 2 magnetic switches (option).

Technical Data					
Piston diameter [mm]	16	20	25	32	40
Max. stroke length [mm]	750	1000	1500	1500	1500
Stroke tolerance [mm] up to 1000 mm	0/+1.5				
Stroke tolerance [mm] > 1000 mm	0/+2				
Temperature range [°C]	0 to 60				
Operating medium	Filtered compr. air, dry, lubricated or unlubricated * . [other media on request]				
Air supply port size	M5	G1/8	G1/8	G1/8	G1/4
Magnetic coupling force [N]	157	236	383	703	942
Velocity range [m/s]	0.05 to 0.4				
Min. operating pressure [bar]	2.3	2			
Max. operating pressure [bar]	6.5	7			
Weight [kg]					
at 0 mm stroke	0.9	1.52	1.70	3.63	5.44
per 100 mm stroke	0.2	0.33	0.42	0.53	0.86

* if external lubrication is added, this must always be continued.

Materials	
Cylinder barrel	Stainless steel
Carriage	Al, anodized
End cap	Al, anodized
Seals	NBR
Guide rods	Steel, chrome plated

Rodless Pneumatic Cylinder
Magnetically Coupled

P1Z Series Guided Version

Ø 16 - 40 mm

Mounting and technical data

The loads can be fixed onto the guide carriage by 4 tapped holes.

Cylinder mounting provided with 4 tapped and counterbored holes. Additional mountings are not required.

P1Z Series

Guided Version

Ø 16 - 40 mm

Forces [N]					
Piston Ø	16	20	25	32	40
Theoretical force at 6 bar [N]	120	188	295	483	754
Max. magnetic coupling force [N]	157	236	383	703	942

Permissible lateral force, depending on the stroke length

Loads, forces and moments



Dynamic forces must not exceed the maximum magnetic coupling force!

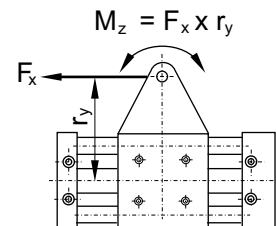
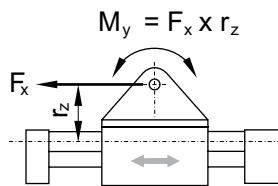
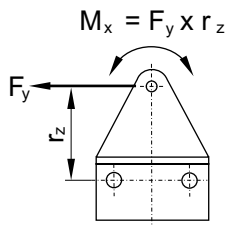
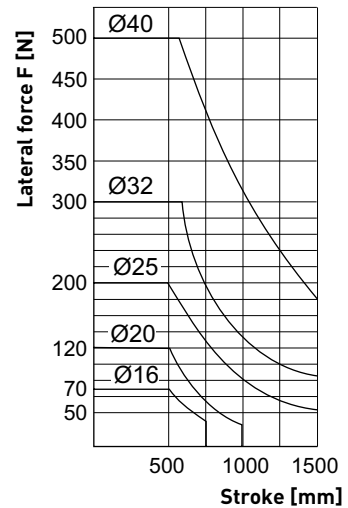
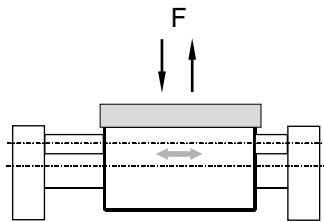

Ø [mm]	Max. Moment M_x [Nm]	Max. Moment M_y [Nm]	Max. Moment M_z [Nm]
16	0.5	2.4	2.4
20	1.0	5.0	5.0
25	1.8	9.5	9.5
32	3.0	15.0	15.0
40	4.5	24.0	24.0

Permissible moment M_x depending on the stroke length

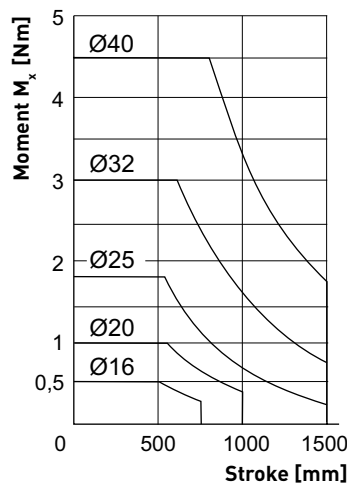

Permissible axial load, vertical mounting

Rodless Pneumatic Cylinder
Magnetically Coupled

P1Z Series

Guided Version

Ø 16 - 40 mm

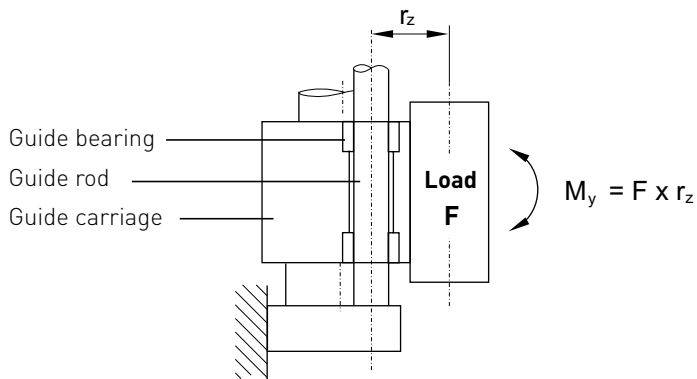

For vertical application please refer to the values in the diagrams !

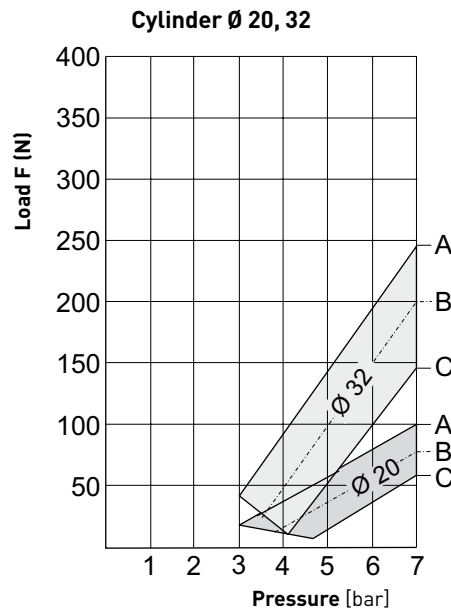
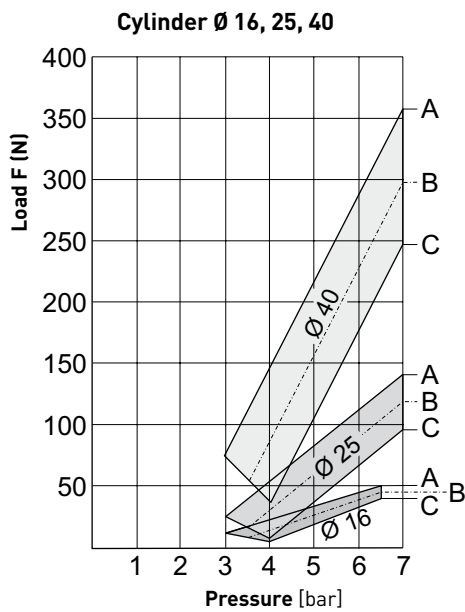

- A** = curve at moment $M_y = 0$
- B** = curve at moment $M_y/2 =$ see **column B**
- C** = curve at moment $M_{y\max.} =$ see **column C**

Ø [mm]	Max. Load F [N]	B Moment My / 2 [Nm]	C Max. Moment My [Nm]
16	50.0	1.2	2.4
20	100.0	2.5	5.0
25	140.0	4.75	9.5
32	240.0	7.5	15.0
40	360.0	12	24.0

P1Z Series Guided Version

Ø 16 - 40 mm

Dimensions

Dimensions [mm]

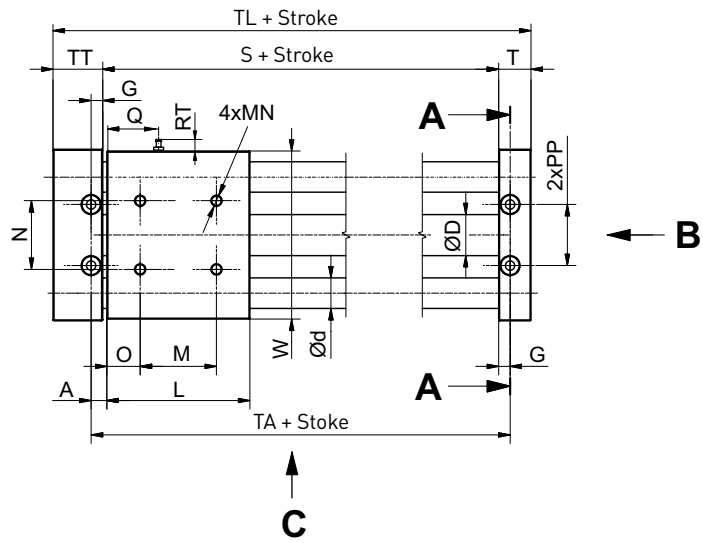

View C

View B

View A-A

End caps with 4 mounting holes for the Al-profile guide (page 20)

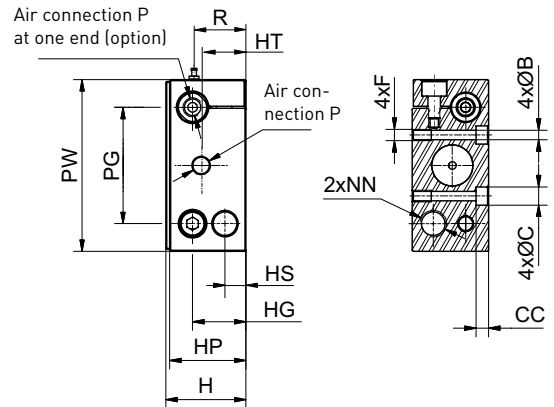
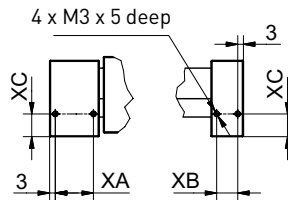

Ø [mm]	A	ØB	ØC	CC	ØD	Ød	F x depth	G	H	HG	HP	HS	HT	L	M	MN x depth
16	8	4.3	8	4.5	17.4	12	M5 x 10	6	34	25	33.5	12	21.5	65	34	M5 x 8
20	8	5.5	9.5	6.5	21.4	16	M6 x 10	6	42	28	40	12	23.5	75	40	M6 x 10
25	10	7	11	6.5	26.4	16	M8 x 10	8	54	32	52	40	24.5	80	40	M8 x 10
32	13.5	8.7	14	8	33.6	20	M10 x 15	10	66	46	64	20	41	91	60	M8 x 12
40	12.5	8.7	14	8	41.6	25	M10 x 15	10.5	76	50	74	56	28	95	65	M8 x 12

Ø [mm]	N	O	P	PG	PP	PW	Q	R	RT	S	T	TA	TL	TT	W	XA	XB	XC
16	30	15.5	M5	50	27	70	-	-	-	69	14	81	106	23	68	17	8	12
20	36	17.5	G1/8	61	32	90	-	-	-	79	17	91	122	26	88	20	11	12
25	70	20	G1/8	70	42	100	23	34	9	84	17	100	127	26	97	20	11	32
32	50	15.5	G1/8	86	50	122	-	-	-	97	20	117	145	28	118	22	14	12
40	105	15	G1/4	104	64	145	25.5	59	9	99	22	120	156	35	142	28	16	42

Standard: Elastomeric bumpers

Rodless Pneumatic Cylinder
Magnetically Coupled

P1Z Series Guided Version

Ø 16 - 40 mm

Dimensions

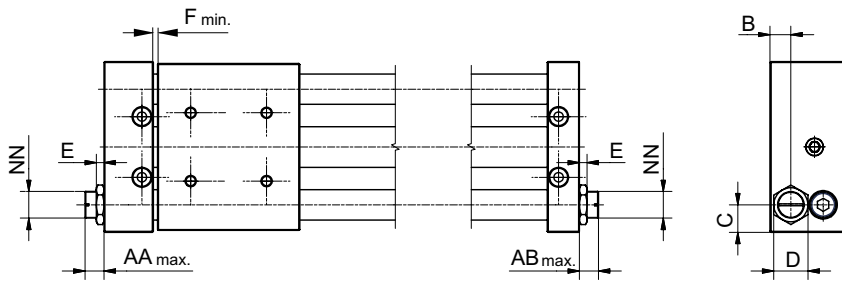

Ø [mm]	AA _{max.}	AB _{max.}	B	C	D	E	F _{min.}	NN
16	13	13	12	10	14	4	2	M10X1
20	10	10	11	14.5	17	6	2	M14X1.5
25	11	20	40	15	17	6	2	M14x1.5
32	12	12	20	18	27	6	2,5	M20X1.5
40	11	11	56	20.5	27	6	2	M20x1.5

Cushioning diagram for elastomeric bumpers

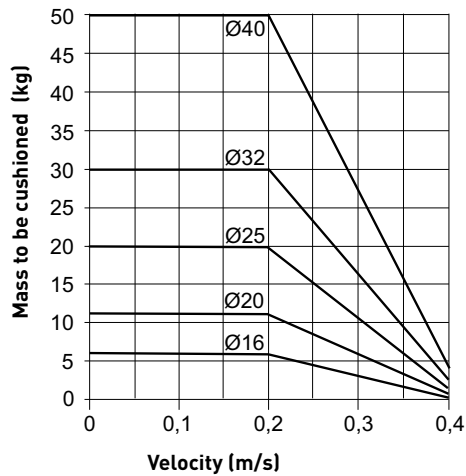

The diagram shows the capacities of the P1Z cylinders with elastomeric bumpers.

If the intersection between speed and mass is above the curves, it is imperative to use hydraulic shock absorbers to prevent cylinder damage.

Example:

Cylinder Ø 32 mm, at a velocity of 0.3 m/s with a mass of 25 kg choose hydraulic shock absorbers.

Cylinder Ø 20 mm, at a velocity of 0.2 m/s with a mass of 10 kg choose the elastomeric bumpers.

P1Z Series Guided Version

Ø 16 - 40 mm

Option: Hydraulic shock absorbers

Dimensions

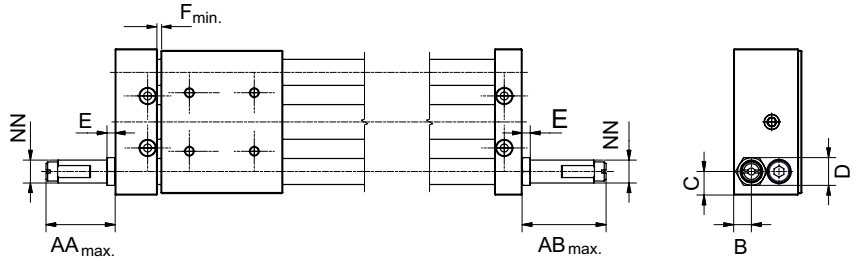

Ø [mm]	AA _{max.}	AB _{max.}	B	C	D	E	F _{min.}	NN
16	18	27	12	10	12	4	2	M10X1
20	47	56	11	14.5	17	6	2	M14X1.5
25	47	56	40	15	17	6	2	M14x1.5
32	56	66	20	18	23	8	3.5	M20x1.5
40	51	64	56	20.5	23	8	2	M20x1.5

Option: Al-profile rail for magnetic switches

Position sensing

The rail is located on the same side as the end of stroke cushioning elements (Bumpers or shocks).

Reed switches or electronic sensors can be moved in the profile rail along the entire stroke length.



Dimensions (Ø 16 - 40 mm)

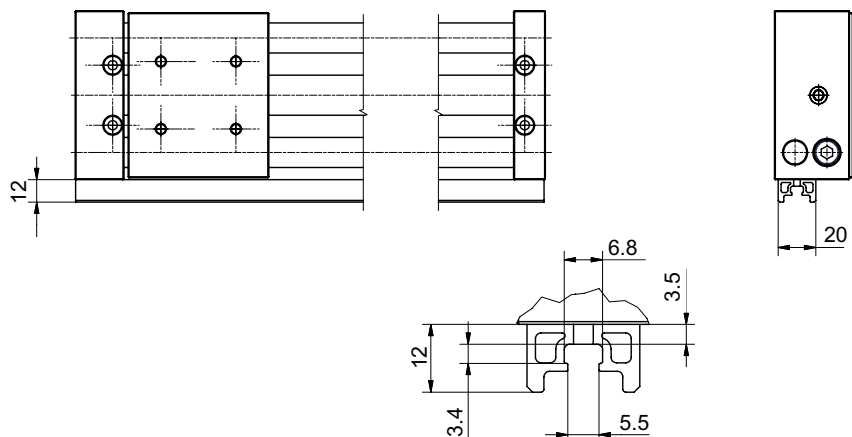

Magnetic Switches

Reed Switch and Electronic Sensor

Series P8S

Technical Data			
Magnetic sensor	Unit	P8S-GR	P8S-GP
Electrical Characteristics			
Switching output / function		Reed / NO	PNP / NO
Electric configuration		2-pole	3-pole
Indicator LED yellow		yes	
Operating voltage U_b	V	10 - 30 AC/DC	10 - 30 DC
Ripple of U_b	%	≤ 10	-
Voltage drop	V	≤ 3	≤ 2
Power consumption unloaded $U_b = 24$ V	mA	-	≤ 10
Continuous current	mA	≤ 100	≤ 200
Max. switching capacity	W	≤ 6	-
Switchable capacity load	nF	100	-
Switching frequency	Hz	≤ 400	≤ 5000
Time delay before availability	ms	1.5 / 0.5	0.5 / 25
Switch point accuracy	mm	≤ 0.2	≤ 0.2
Switching distance	mm	ca. 15	ca. 15
Hysteresis	mm	2	2
EMC to EN 60947-5-2		yes	
Lifetime		≥ 40 x 10 ⁶ cycles	unlimited
Short circuit protection		-	yes
Reverse polarity protection		-	yes
Power-up pulse Suppression		-	yes
Protection for inductive load		-	yes
ATEX certification		-	yes
Category		-	3D / 3G
Mechanical characteristics			
Housing		PA12	
Cable type		PUR / black	
Cable cross section	mm ²	2 x 0.14	
Bending radius fixed installation	mm	≥ 20	
Bending radius moving	mm	≥ 30	
Shock resistance			
Protection EN 60529	IP	68	
Ambient temperature range	°C	- 25 to + 80	
Vibration EN 60068-2-6	G	15, 11 ms, 10 up to 55 Hz, 1 mm	
Permanent shock EN 60068-2-29	G	30, 11 ms, 1000 shocks per axis	
Shock EN 60068-2-27	G	50, 11 ms	

Magnetic Switches

Magnet switches are used for the contactless sensing of end or intermediate positions of the carriage.

The new generation of t-slot switches convince with easy mounting avoiding special tools and with a drop in mounting.

Due to new electronics the hysteresis is very small and allows a very accurate switching point.

Electronic Sensor

This type of electronic sensor with PNP function provides a short circuit as well as a transient protection as standard.

The new state of the art electronics inside can be used for endless lifetime. Especially if the application demand for high switching frequency is required.

Reed Switch

The 2-pole reed switch is a price attractive alternative while offering reliable and proven function for a lot of applications.

An integrated LED shows the status of the switch visually.

Carriage speed and switching distance affect signal duration and should be considered in conjunction with the minimum reaction time of ancillary control equipment.

In accordance to this, the contact travel must be included in the calculation.

$$\text{Min. reaction time} = \frac{\text{Switching distance}}{\text{Piston speed}}$$



Magnetic Switches

Reed Switch and Electronic Sensor

Series P8S

Electrical Connection Reed Switch

normally open

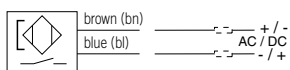

Electrical Connection Electronic Sensor PNP

normally open

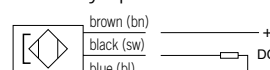

Electric Service Life Protective Measures

The reed switches are sensitive to excessive currents and inductions. With high switching frequencies and inductive loads such as relays, solenoid valves or lifting magnets, service life will be greatly reduced.

With resistive and capacitive loads with high switch-on current, such as light bulbs, a protective resistor should be fitted. This also applies to long cable lengths and voltages over 100 V.

In the switching of inductive loads such as relays, solenoid valves and lifting magnets, voltage peaks (transients) are generated which must be suppressed by protective diodes, RC loops or varistors.

Connection Examples

- Load with protective circuits
- (a) Protective resistor for light bulb
- (b) Freewheel diode on inductivity
- (c) Varistor on inductivity
- (d) RC element on inductivity

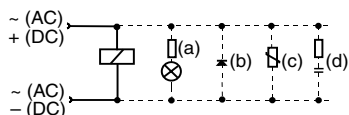

For the type P8S-GP, external protective circuits are not normally needed.

Dimensions (mm) – Type P8S-GR, P8S-GP

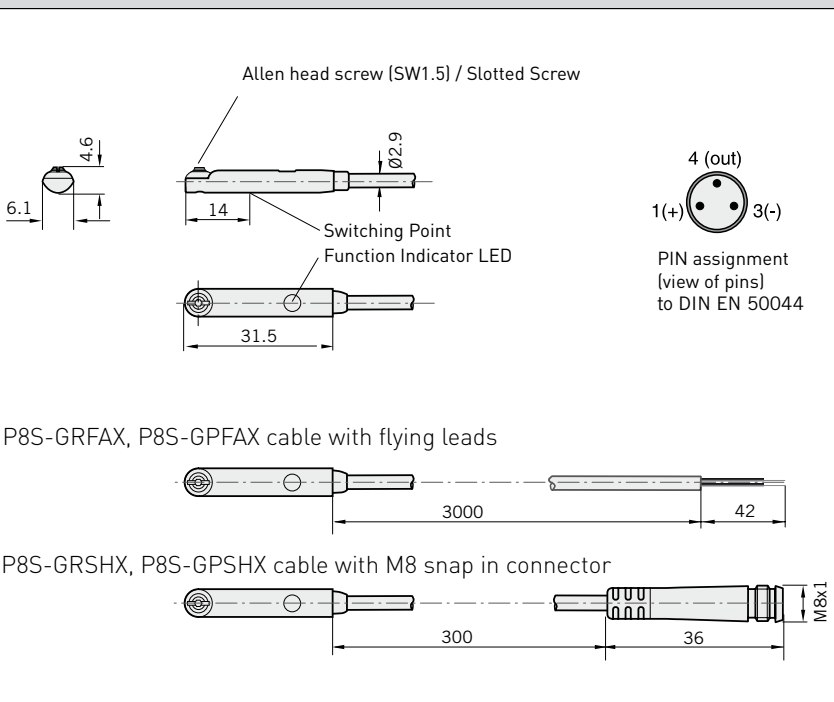

Installation for Magnetic T-Slot Switches

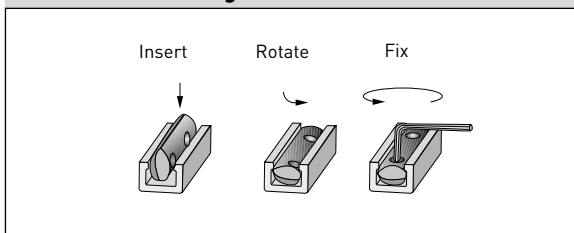

Order number

	M8 Connector, snap in, 3-pole 0.3 m	FL flying leads 3 m
Reed NO (2-wire)	P8S-GRSHX	P8S-GRFAX
PNP NO	P8S-GPSHX	P8S-GPFAX

Order instructions

Basic cylinder (15 digits)													With option (18 digits)																				
P	1	Z	M	0	1	6	T	C	N	0	8	5	0	W	N	M	L																
				<table border="1"> <thead> <tr> <th colspan="2">Piston diameter</th> </tr> </thead> <tbody> <tr> <td>016</td> <td>∅ 16 mm</td> </tr> <tr> <td>020</td> <td>∅ 20 mm</td> </tr> <tr> <td>025</td> <td>∅ 25 mm</td> </tr> <tr> <td>032</td> <td>∅ 32 mm</td> </tr> <tr> <td>040</td> <td>∅ 40 mm</td> </tr> </tbody> </table>			Piston diameter		016	∅ 16 mm	020	∅ 20 mm	025	∅ 25 mm	032	∅ 32 mm	040	∅ 40 mm				<table border="1"> <thead> <tr> <th colspan="2">Options</th> </tr> </thead> <tbody> <tr> <td>B</td> <td>without</td> </tr> <tr> <td>W</td> <td>with</td> </tr> </tbody> </table>			Options		B	without	W	with			
Piston diameter																																	
016	∅ 16 mm																																
020	∅ 20 mm																																
025	∅ 25 mm																																
032	∅ 32 mm																																
040	∅ 40 mm																																
Options																																	
B	without																																
W	with																																
				<table border="1"> <thead> <tr> <th colspan="2">Version</th> </tr> </thead> <tbody> <tr> <td>G</td> <td>Guided version and air connection on both sides</td> </tr> <tr> <td>T</td> <td>Guided version and air connection at one end</td> </tr> </tbody> </table>			Version		G	Guided version and air connection on both sides	T	Guided version and air connection at one end				<table border="1"> <thead> <tr> <th colspan="2">Air supply port type</th> </tr> </thead> <tbody> <tr> <td>M</td> <td>Metric thread (∅ 16 mm)</td> </tr> <tr> <td>B</td> <td>G-thread (∅ 20 - 40 mm)</td> </tr> <tr> <td colspan="2">(Other types on request)</td> </tr> </tbody> </table>			Air supply port type		M	Metric thread (∅ 16 mm)	B	G-thread (∅ 20 - 40 mm)	(Other types on request)								
Version																																	
G	Guided version and air connection on both sides																																
T	Guided version and air connection at one end																																
Air supply port type																																	
M	Metric thread (∅ 16 mm)																																
B	G-thread (∅ 20 - 40 mm)																																
(Other types on request)																																	
				<table border="1"> <thead> <tr> <th colspan="2">End of stroke cushioning</th> </tr> </thead> <tbody> <tr> <td>C</td> <td>with elastomeric bumpers</td> </tr> <tr> <td>H</td> <td>with two hydraulic shock absorbers</td> </tr> </tbody> </table>			End of stroke cushioning		C	with elastomeric bumpers	H	with two hydraulic shock absorbers				<table border="1"> <thead> <tr> <th colspan="2">Position sensing</th> </tr> </thead> <tbody> <tr> <td>N</td> <td>without</td> </tr> <tr> <td>L</td> <td>Al-profile without magnetic switch</td> </tr> <tr> <td>S</td> <td>2 Reed switches, 0.3 m with M8 connector, snap in</td> </tr> <tr> <td>C</td> <td>2 Reed switches, 3 m flying leads</td> </tr> <tr> <td>K</td> <td>2 Electronic sensors PNP 0.3 m with M8 connector, snap in</td> </tr> <tr> <td>H</td> <td>2 Electronic sensors PNP 3 m flying leads</td> </tr> </tbody> </table>			Position sensing		N	without	L	Al-profile without magnetic switch	S	2 Reed switches, 0.3 m with M8 connector, snap in	C	2 Reed switches, 3 m flying leads	K	2 Electronic sensors PNP 0.3 m with M8 connector, snap in	H	2 Electronic sensors PNP 3 m flying leads	
End of stroke cushioning																																	
C	with elastomeric bumpers																																
H	with two hydraulic shock absorbers																																
Position sensing																																	
N	without																																
L	Al-profile without magnetic switch																																
S	2 Reed switches, 0.3 m with M8 connector, snap in																																
C	2 Reed switches, 3 m flying leads																																
K	2 Electronic sensors PNP 0.3 m with M8 connector, snap in																																
H	2 Electronic sensors PNP 3 m flying leads																																
				<table border="1"> <thead> <tr> <th colspan="2">Stroke length</th> </tr> <tr> <th>max. stroke [mm]</th> <th>piston ∅ [mm]</th> </tr> </thead> <tbody> <tr> <td>750</td> <td>∅ 16</td> </tr> <tr> <td>1000</td> <td>∅ 20</td> </tr> <tr> <td>1500</td> <td>∅ 25</td> </tr> <tr> <td>1500</td> <td>∅ 32</td> </tr> <tr> <td>1500</td> <td>∅ 40</td> </tr> </tbody> </table>			Stroke length		max. stroke [mm]	piston ∅ [mm]	750	∅ 16	1000	∅ 20	1500	∅ 25	1500	∅ 32	1500	∅ 40													
Stroke length																																	
max. stroke [mm]	piston ∅ [mm]																																
750	∅ 16																																
1000	∅ 20																																
1500	∅ 25																																
1500	∅ 32																																
1500	∅ 40																																

Order code examples:

- **P1ZM016TCN0100B** Cylinder guided version -∅ 16 mm, stroke 100 mm, with air connection at one end and elastomeric bumpers.
- **P1ZM020GHN1000WNBL** Cylinder guided version -∅ 20 mm, stroke 1000 mm, with air connection on both sides, with two hydraulic shock absorbers and profile rail for magnetic switches.

Spare parts

Rodless Pneumatic Cylinder
Magnetically Coupled

P1Z Series

Ø 16 - 40 mm

Elastomeric bumpers (2 pieces)



Elastomeric bumper (2 pieces)	
Ø [mm]	Order no.
16	14332
20	14333
25	
32	14334
40	

Spare parts

Screw in one-way flow control valve with exhaust restrictor (1 piece)



Screw in one-way flow control valve with exhaust restrictor (1 piece)		
Ø [mm]	Connection	Order no.
16	M5	KT0433
20	G 1/8	KW0520
25		
32	G 1/4	KW0521
40		

Parker Worldwide

Europe, Middle East, Africa

AE – United Arab Emirates, Dubai
Tel: +971 4 8127100
parker.me@parker.com

AT – Austria, Wiener Neustadt
Tel: +43 (0)2622 23501-0
parker.austria@parker.com

AT – Eastern Europe, Wiener Neustadt
Tel: +43 (0)2622 23501 900
parker.easteurope@parker.com

AZ – Azerbaijan, Baku
Tel: +994 50 2233 458
parker.azerbaijan@parker.com

BE/LU – Belgium, Nivelles
Tel: +32 (0)67 280 900
parker.belgium@parker.com

BY – Belarus, Minsk
Tel: +375 17 209 9399
parker.belarus@parker.com

CH – Switzerland, Etoy
Tel: +41 (0)21 821 87 00
parker.switzerland@parker.com

CZ – Czech Republic, Klecany
Tel: +420 284 083 111
parker.czechrepublic@parker.com

DE – Germany, Kaarst
Tel: +49 (0)2131 4016 0
parker.germany@parker.com

DK – Denmark, Ballerup
Tel: +45 43 56 04 00
parker.denmark@parker.com

ES – Spain, Madrid
Tel: +34 902 330 001
parker.spain@parker.com

FI – Finland, Vantaa
Tel: +358 (0)20 753 2500
parker.finland@parker.com

FR – France, Contamine s/Arve
Tel: +33 (0)4 50 25 80 25
parker.france@parker.com

GR – Greece, Athens
Tel: +30 210 933 6450
parker.greece@parker.com

HU – Hungary, Budapest
Tel: +36 1 220 4155
parker.hungary@parker.com

IE – Ireland, Dublin
Tel: +353 (0)1 466 6370
parker.ireland@parker.com

IT – Italy, Corsico (MI)
Tel: +39 02 45 19 21
parker.italy@parker.com

KZ – Kazakhstan, Almaty
Tel: +7 7272 505 800
parker.easteurope@parker.com

NL – The Netherlands, Oldenzaal
Tel: +31 (0)541 585 000
parker.nl@parker.com

NO – Norway, Asker
Tel: +47 66 75 34 00
parker.norway@parker.com

PL – Poland, Warsaw
Tel: +48 (0)22 573 24 00
parker.poland@parker.com

PT – Portugal, Leca da Palmeira
Tel: +351 22 999 7360
parker.portugal@parker.com

RO – Romania, Bucharest
Tel: +40 21 252 1382
parker.romania@parker.com

RU – Russia, Moscow
Tel: +7 495 645-2156
parker.russia@parker.com

SE – Sweden, Spånga
Tel: +46 (0)8 59 79 50 00
parker.sweden@parker.com

SK – Slovakia, Banská Bystrica
Tel: +421 484 162 252
parker.slovakia@parker.com

SL – Slovenia, Novo Mesto
Tel: +386 7 337 6650
parker.slovenia@parker.com

TR – Turkey, Istanbul
Tel: +90 216 4997081
parker.turkey@parker.com

UA – Ukraine, Kiev
Tel: +380 44 494 2731
parker.ukraine@parker.com

UK – United Kingdom, Warwick
Tel: +44 (0)1926 317 878
parker.uk@parker.com

ZA – South Africa, Kempton Park
Tel: +27 (0)11 961 0700
parker.southafrica@parker.com

North America

CA – Canada, Milton, Ontario
Tel: +1 905 693 3000

US – USA, Cleveland
Tel: +1 216 896 3000

Asia Pacific

AU – Australia, Castle Hill
Tel: +61 (0)2-9634 7777

CN – China, Shanghai
Tel: +86 21 2899 5000

HK – Hong Kong
Tel: +852 2428 8008

IN – India, Mumbai
Tel: +91 22 6513 7081-85

JP – Japan, Tokyo
Tel: +81 (0)3 6408 3901

KR – South Korea, Seoul
Tel: +82 2 559 0400

MY – Malaysia, Shah Alam
Tel: +60 3 7849 0800

NZ – New Zealand, Mt Wellington
Tel: +64 9 574 1744

SG – Singapore
Tel: +65 6887 6300

TH – Thailand, Bangkok
Tel: +662 717 8140

TW – Taiwan, Taipei
Tel: +886 2 2298 8987

South America

AR – Argentina, Buenos Aires
Tel: +54 3327 44 4129

BR – Brazil, Sao Jose dos Campos
Tel: +55 12 4009 3500

CL – Chile, Santiago
Tel: +56 2 623 1216

MX – Mexico, Apodaca
Tel: +52 81 8156 6000

VE – Venezuela, Caracas
Tel: +58 212 238 5422

Parker Hannifin GmbH

Pat-Parker-Platz 1
D-41564 Kaarst (Germany)
Tel: +49 2131 4016-0
Fax: +49 2131 4016-9199
E-Mail: parker.germany@parker.com
Internet: www.parker.com, www.parker-origa.com

